



REV	DESCRIPTION	DATE	BY	CHKD
A	Old Block C Removed from Drawing and New Block C Added	15/02/10	AJL	AJL



DO NOT SCALE

This plan only to be used for planning purposes. The main contractor shall verify all dimensions, details and levels prior to commencement of work. All errors and omissions to be reported immediately to the Supervising Officer. Variations & modifications to work shown on these drawings shall not be carried out without written permission from the Supervising Officer. This drawing is the exclusive property of the Supervising Officer and can be reproduced only with the permission of the Supervising Officer in which case the reproduction must bear their name as supervising Officer.

Maps are reproduced from Ordnance Survey data with the permission of the controller of Her Majesty's Stationery Office. Crown copyright/licence No. 100020000. Unauthorised reproduction infringes Crown copyright and may lead to prosecution.

REVISIONS

REV. DATE BY REVISION

PROPERTY SERVICES
 LIBRARY BUILDING
 MOSTYN STREET
 LLANDUDNO
 LL30 2RP
 Tel: (01492) 574296
 Fax: (01492) 574243

ASSET PLAN

PROJECT
 Eirias High

**Eirias Road
 Colwyn Bay
 LL29 7SP**

DRAWING
 GROUND FLOOR

DRAWING PRODUCTION
 Measured Survey

SCALE	DATE	DATE LAST UPDATED
1/200 @ A1	25/09/03	
DRAWN BY	VERIFIED BY	FILE NAME
SI		

UPRN	DWG No	REV
ESD505	ESD505/01	

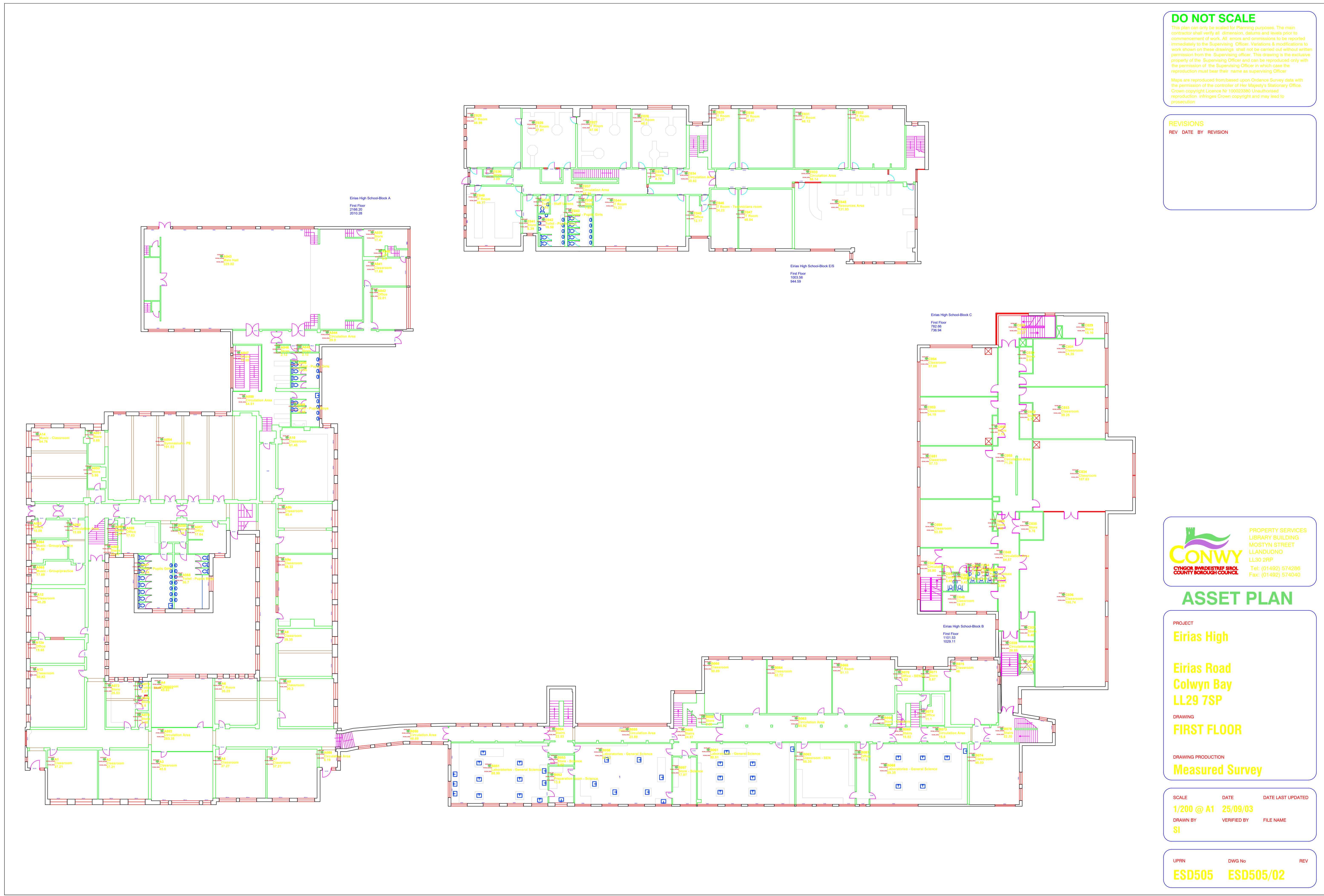

DO NOT SCALE

This plan only to be used for planning purposes. The main contractor shall verify all dimensions, details and levels prior to commencement of work. All errors and omissions to be reported immediately to the Supervising Officer. Variations & modifications to work shown on these drawings shall not be carried out without written permission from the Supervising Officer. This drawing is the exclusive property of the Supervising Officer and can be reproduced only with the permission of the Supervising Officer in which case the reproduction must bear their name as supervising Officer.

Maps are reproduced from Ordnance Survey data with the permission of the controller of Her Majesty's Stationery Office. Crown copyright/licence No. 100020000. Unauthorised reproduction infringes Crown copyright and may lead to prosecution.

REVISIONS

REV	DATE	BY	REVISION

CONWY COUNTY BOROUGH COUNCIL

PROPERTY SERVICES
 LIBRARY BUILDING
 MOSTYN STREET
 LLANDUDNO
 LL30 2RP
 Tel: (01492) 574298
 Fax: (01492) 574243

ASSET PLAN

PROJECT
 Eirias High

**Eirias Road
 Colwyn Bay
 LL29 7SP**

DRAWING
 FIRST FLOOR

DRAWING PRODUCTION
 Measured Survey

SCALE	DATE	DATE LAST UPDATED
1/200 @ A1	25/09/03	
DRAWN BY	VERIFIED BY	FILE NAME
SI		

UPRN	DWG No	REV
ESD505	ESD505/02	



DO NOT SCALE

This plan shall only be used for planning purposes. The main contractor shall verify all dimensions, details and levels prior to commencement of work. All errors and omissions shall be reported immediately to the Supervising Officer. Variations & modifications to work shown on these drawings shall not be carried out without written permission from the Supervising Officer. This drawing is the exclusive property of the Supervising Officer and can be reproduced only with the permission of the Supervising Officer in which case the reproduction must bear their name as supervising Officer.

Maps are reproduced from Ordnance Survey data with the permission of the controller of Her Majesty's Stationery Office. Crown copyright licensed to Ordnance Survey. Unauthorised reproduction infringes Ordnance Survey copyright and may lead to prosecution.

REVISIONS

REV	DATE	BY	REVISION

CONWY
 CONWY PARISH COUNCIL
 COUNTY BOROUGH OF CONWY

PROPERTY SERVICES
 LIBRARY BUILDING
 MOSTYN STREET
 LLANDUDNO
 LL30 2RP
 Tel: (01492) 574296
 Fax: (01492) 574243

ASSET PLAN

PROJECT
 Eirias High

**Eirias Road
 Colwyn Bay
 LL29 7SP**

DRAWING
 SECOND FLOOR

DRAWING PRODUCTION
 Measured Survey

SCALE	DATE	DATE LAST UPDATED
1/200 @ A1	25/09/03	
DRAWN BY	VERIFIED BY	FILE NAME
SI		

UPRN	DWG No	REV
ESD505	ESD505/03	

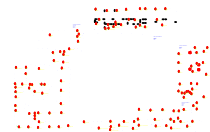

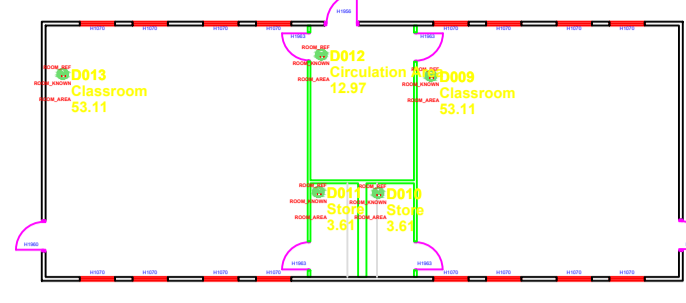

Eirias High School-Block D
Ground Floor
133.74
128.16

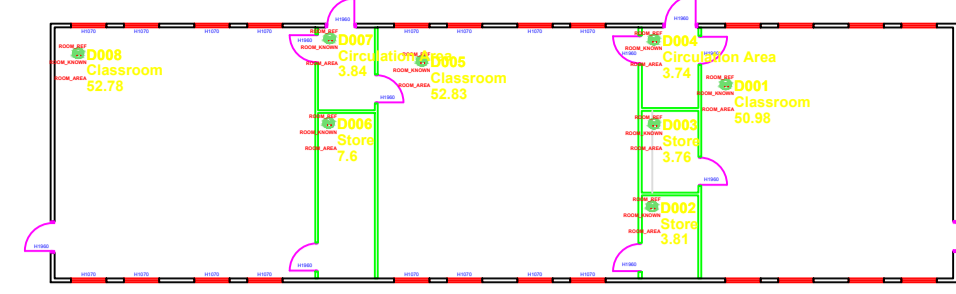

Eirias High School-Block D
Ground Floor
168.8
181.67

Eirias High School-Block E5
Ground Floor
987.86
929.67

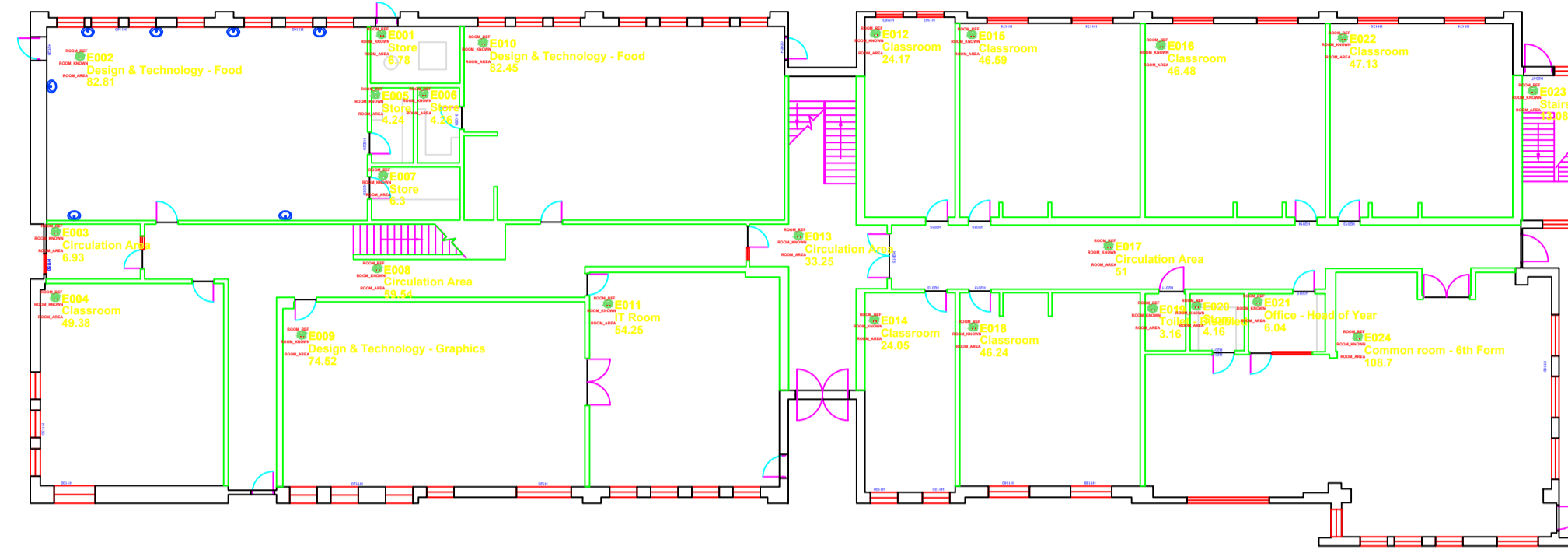

Eirias High School-Block A
Ground Floor
1447.79
1362.58

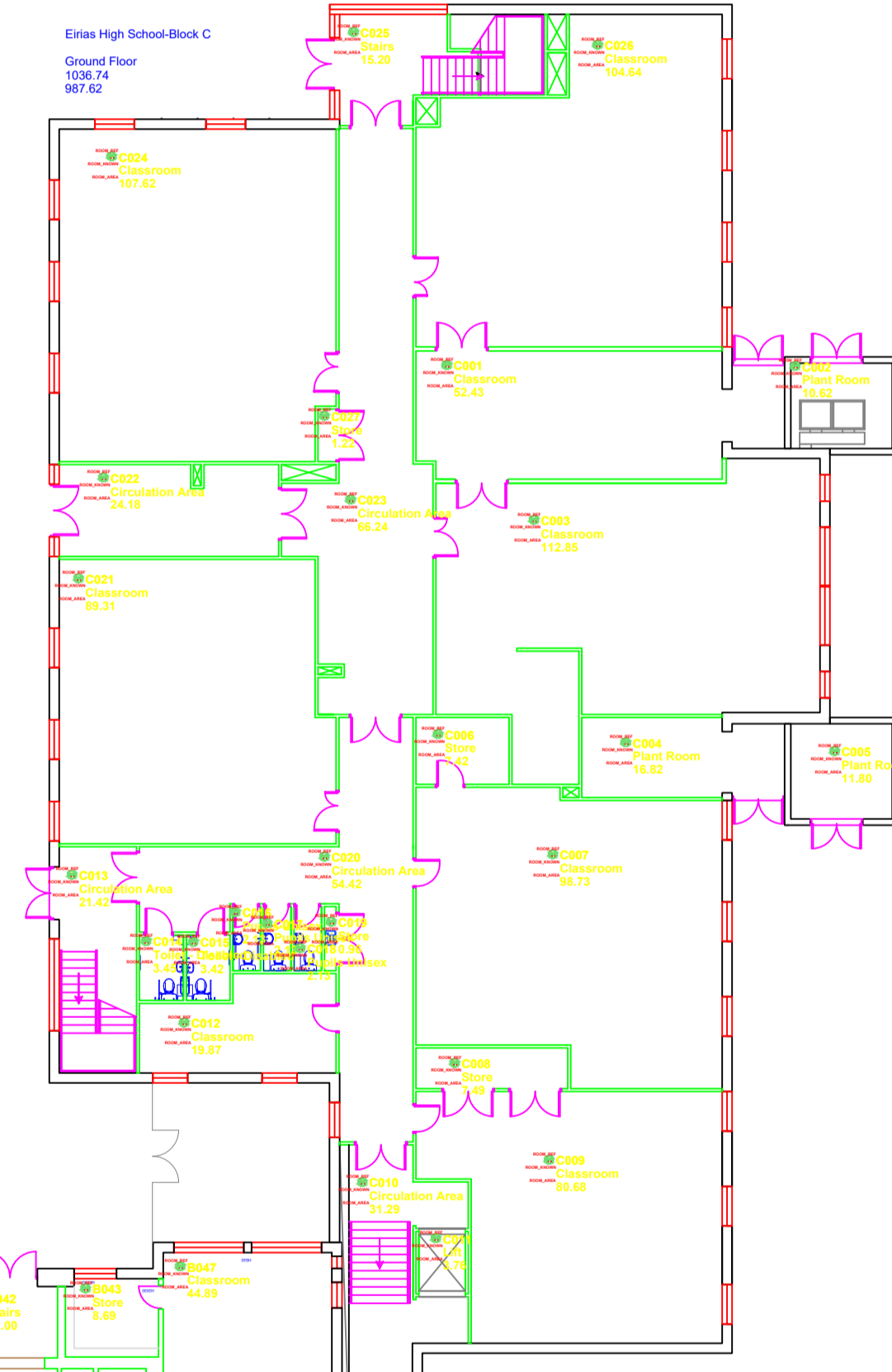
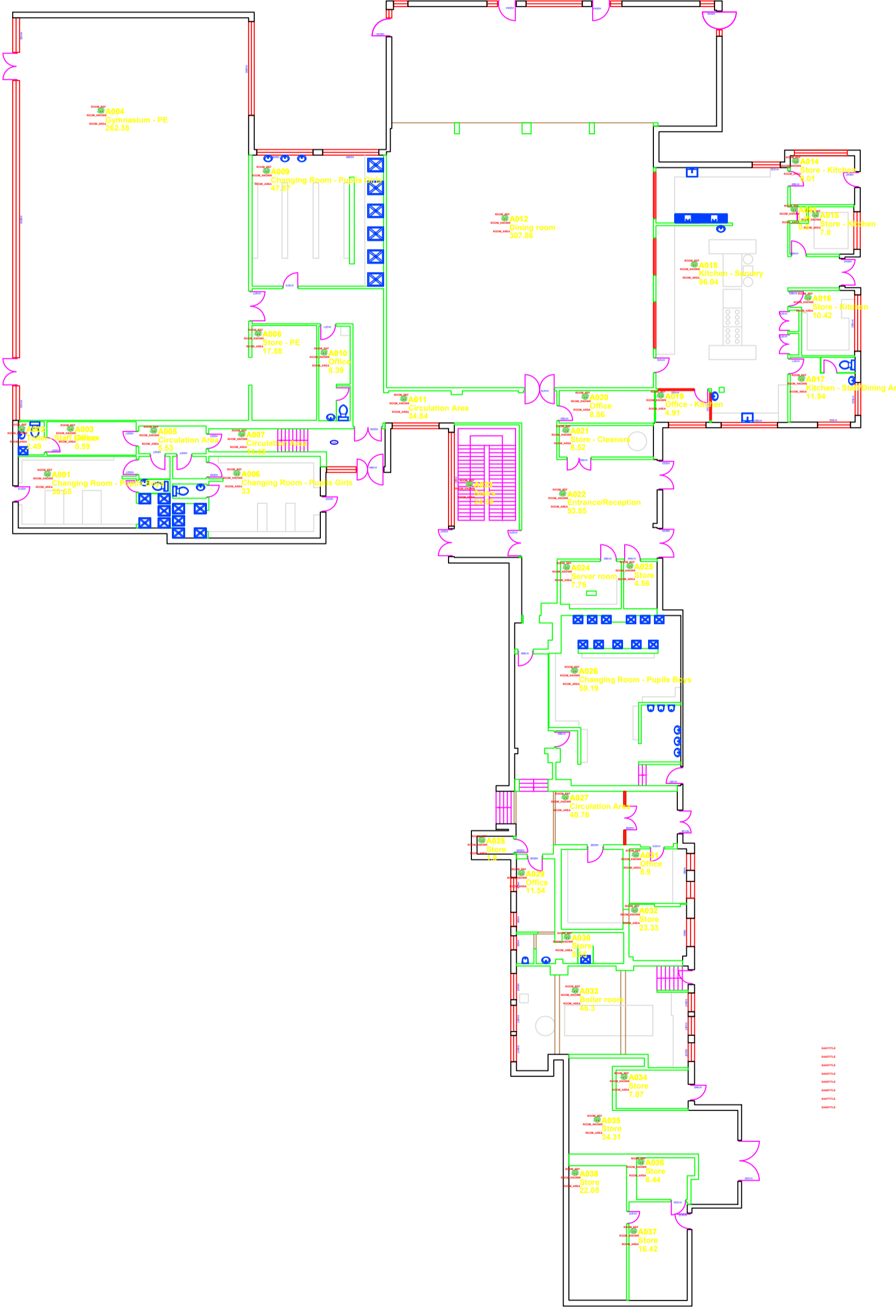

Eirias High School-Block C
Ground Floor
928.14
987.62

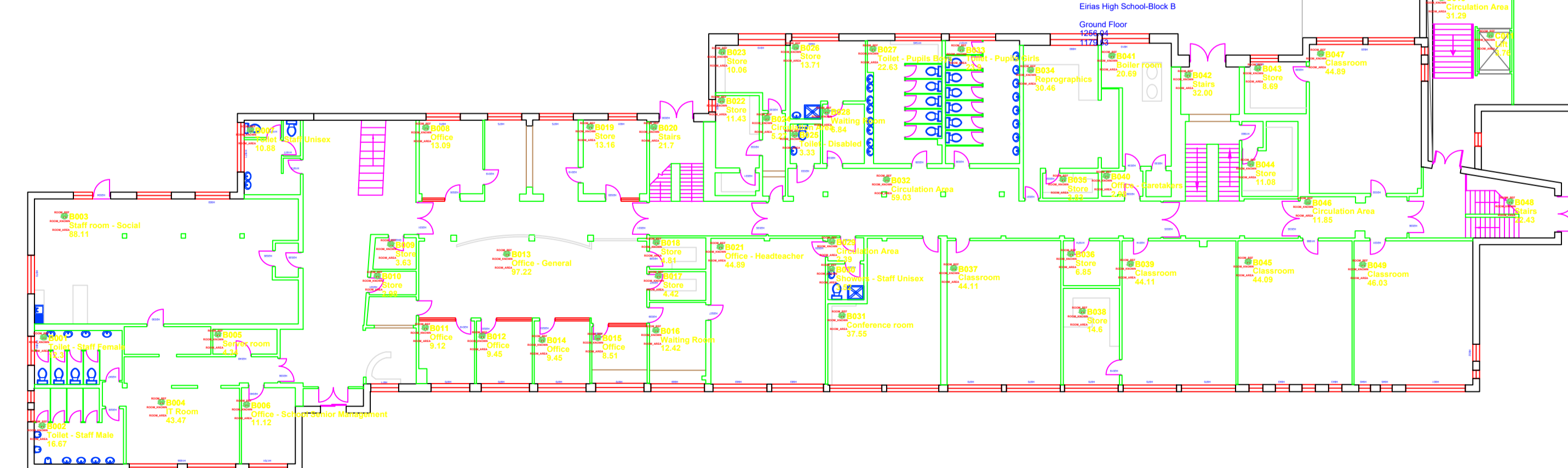

Eirias High School-Block B
Ground Floor
1447.79
1362.58



PROPERTY MANAGEMENT & ASSET SERVICES
DINERTH ROAD
COLWYN BAY
LL28 4UL
Tel: (01492) 574286
Fax: (01492) 574027

PROPERTY
EIRIAS HIGH
EIRIAS ROAD
COLWYN BAY
LL29 7SP

DRAWING
ASSET PLAN
GROUND FLOOR

DRAWING PRODUCTION
SURVEY

SCALE	DATE	DATE LAST UPDATED
NTS	04/12/09	
DRAWN BY S J Lea	VERIFIED BY	FILE NAME
SITE UPN ESD505	DWG No ESD505/04	SHEET No 1 of 3

REV	DESCRIPTION	DATE	BY	CHKD
A	Old Block C Removed from Drawing and New Block C Added	15/02/10	AJL	AJL

REV	DESCRIPTION	DATE	BY	CHKD
A	Old Block C Removed from Drawing and New Block C Added	15/02/10	AJL	AJL



Eirias High School-Block A

Second Floor
169.90
145.25

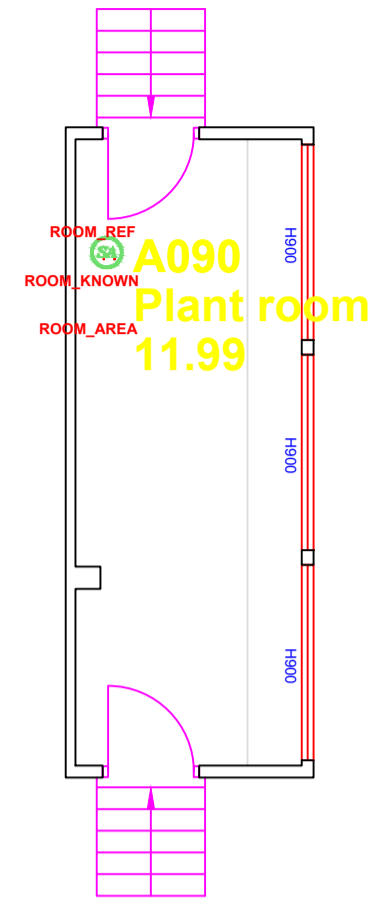
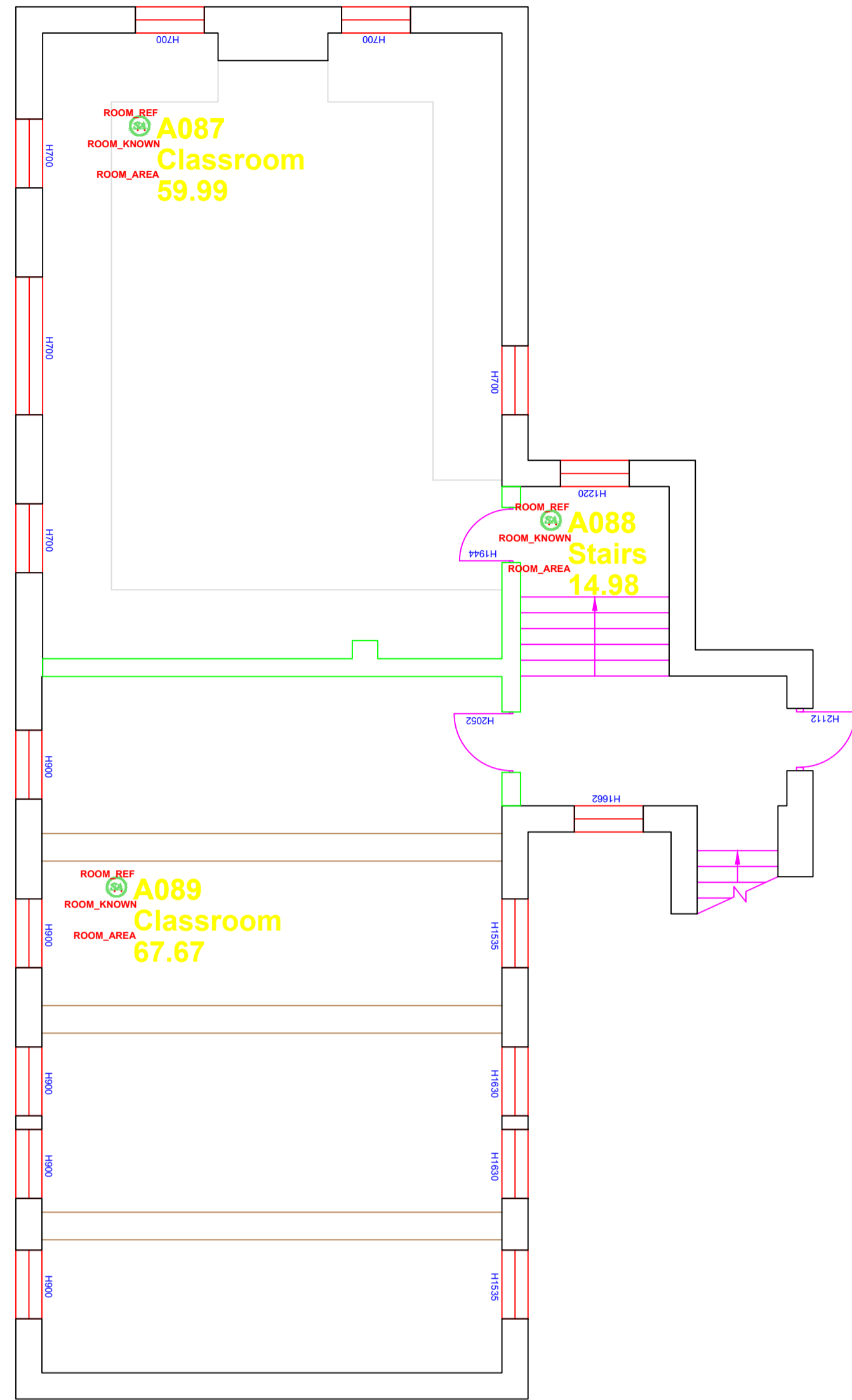

Eirias High School-Block C
Second Floor
998.68
948.88

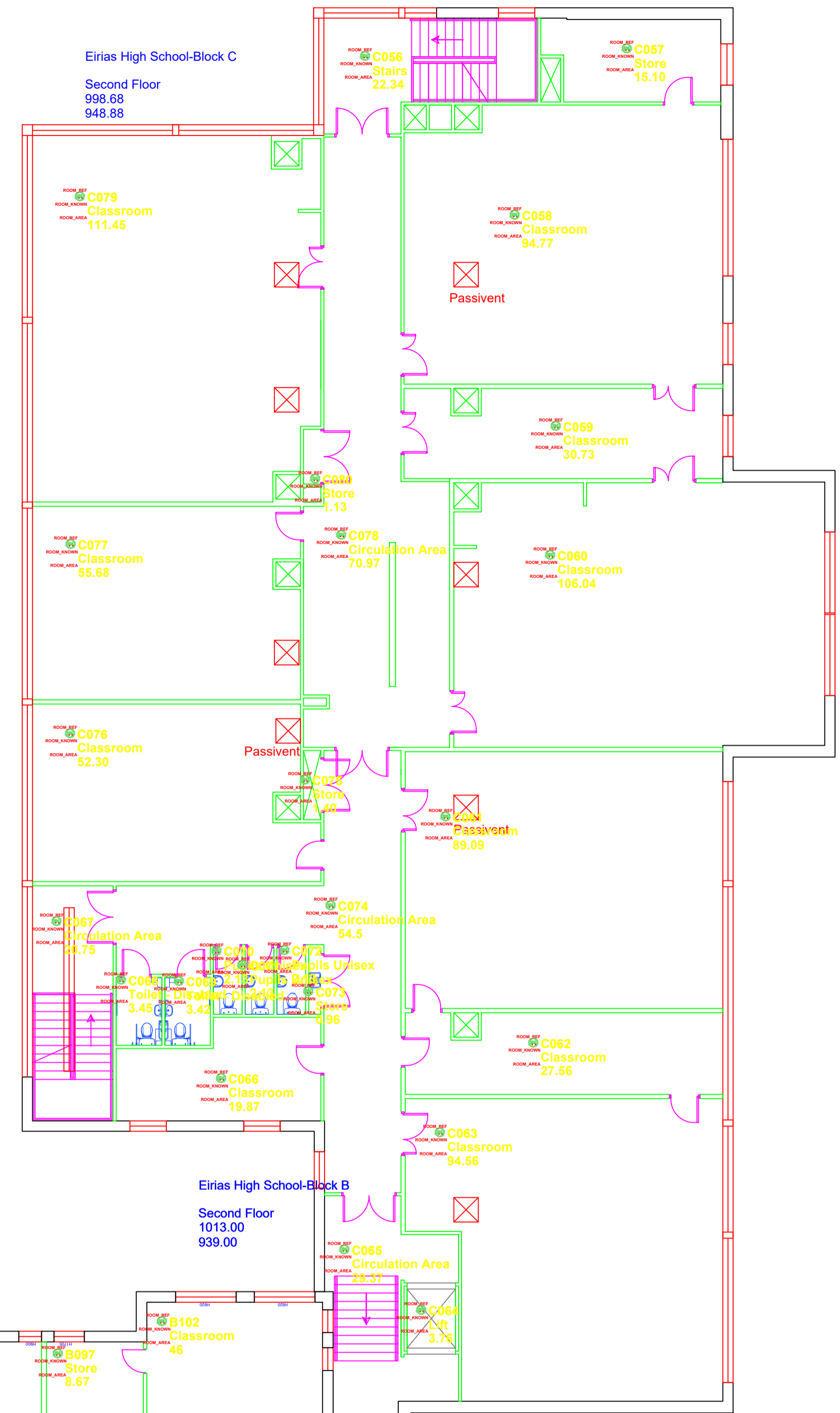

Eirias High School-Block B
Second Floor
1013.00
939.00

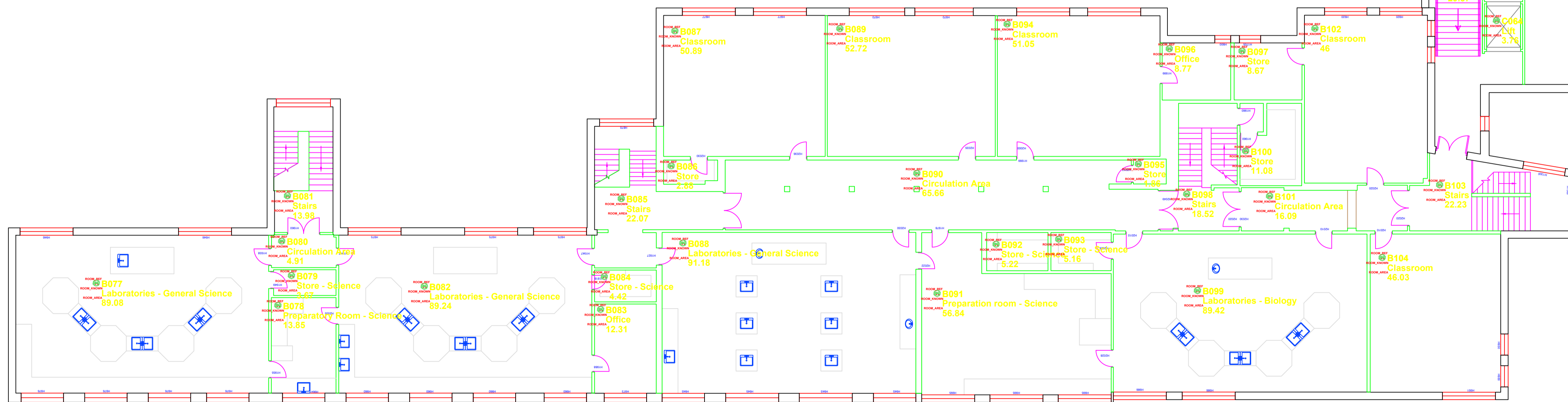

REV	DESCRIPTION	DATE	BY	CHKD
A	Old Block C Removed from Drawing and New Block C Added	15/02/10	AJL	AJL